

MR - Quadrant shower enclosure with 2 sliding doors + 2 fixed panels



MR - Quadrant shower enclosure with 2 sliding doors + 2 fixed panels. Transparent glass and gloss silver profile. Compensation of 25 mm.

Corner radius (mm): 500

Glass thickness (mm): 4

Maximum installation length (mm): 890

Minimum installation length (mm): 865

Suitable for: Shower tray

Type of doors: Sliding doors

Dimensions

Length: 900 mm.

Height: 1900 mm.

Technical drawings

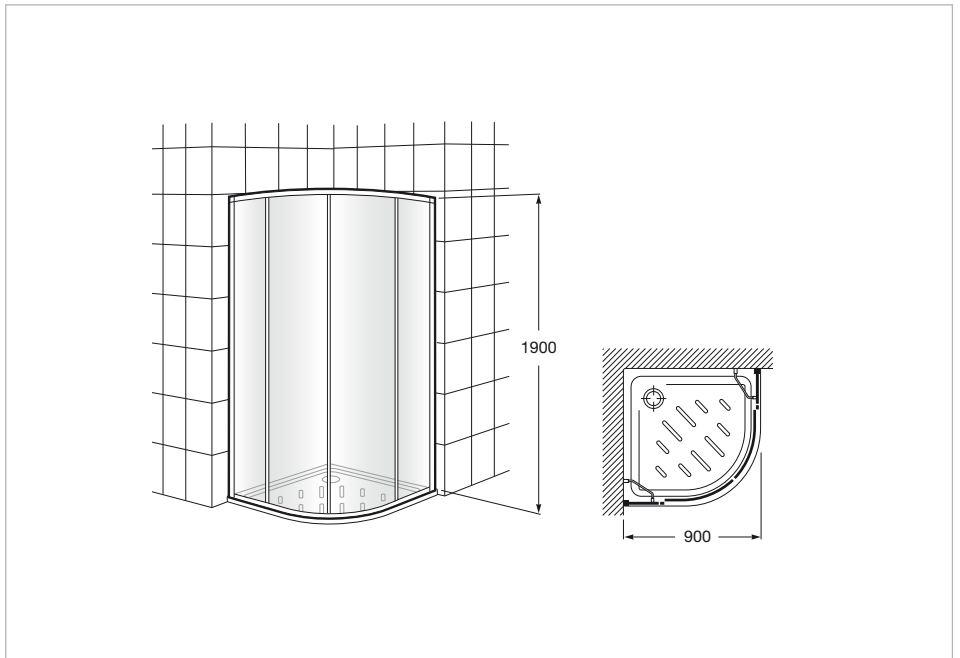

Design, functionality and breadth of range. The collection, with its neutral, pure lines, offers a wide variety of sizes. The combination of this series' products will give you astonishing results in all kind of bathroom spaces.



Designed by
Joan Gaspar

His work has been selected on a number of occasions for the FAD Awards. In 2001, he was awarded its Silver Delta for the Atlas series of lamps made by Maset Iluminación, and received another in 2004 for the Neón de Luz luminaire, again produced by Maset Iluminación.